

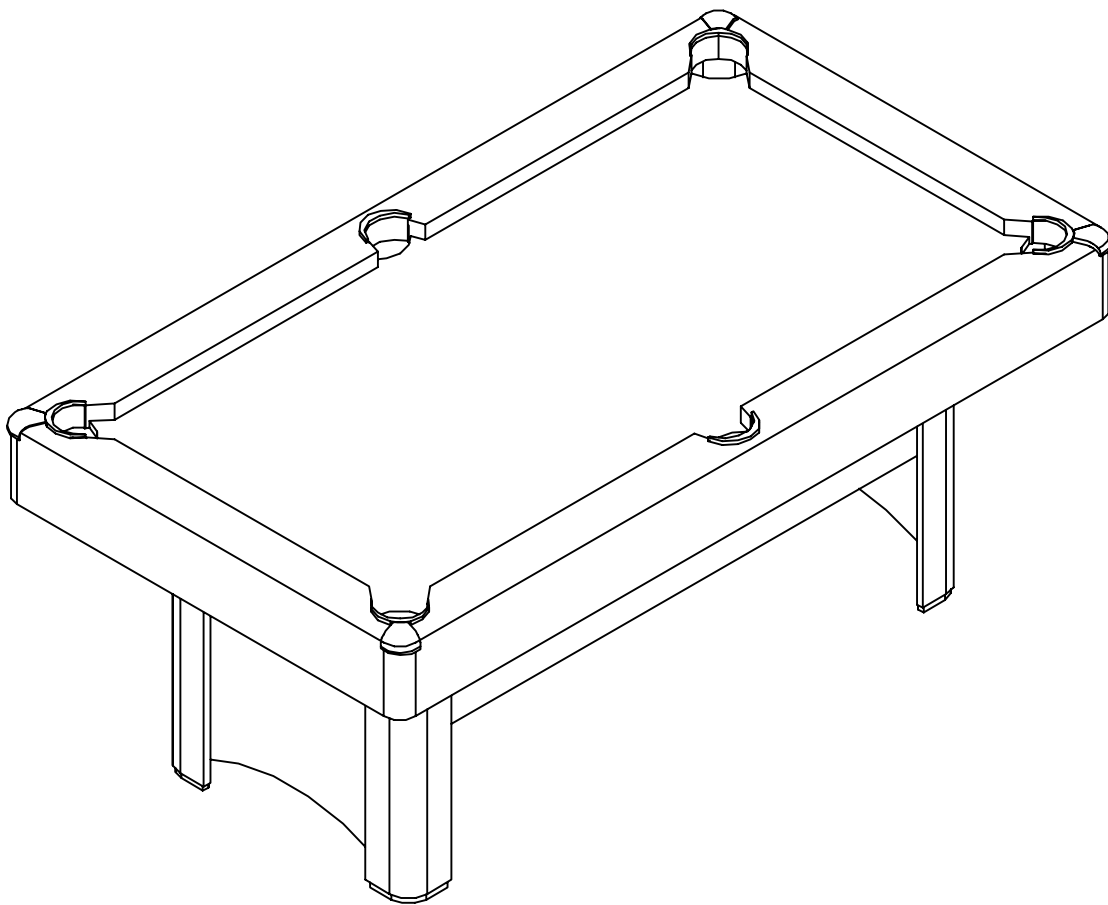

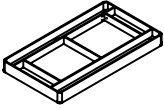







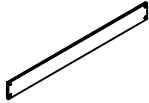

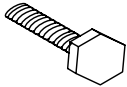
MODEL NAME: 6030.260 6' POOL TABLE

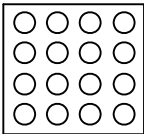

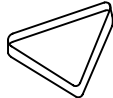
INSTRUCTIONS MANUAL

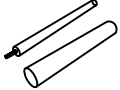
<p>#1</p>  <p>Frame 1 piece</p>	<p>#2</p>  <p>Leg 2 piece</p>	<p>#3</p>  <p>Leg Connecting beam 2 Piece</p>	<p>#4</p>  <p>Leg leveler 4 Piece</p>	<p>#5</p>  <p>round head screw 8 Piece</p>	<p>#6</p>  <p>5/16" bolt 12 Piece</p>
<p>#7</p>  <p>5/16" washer 24 Piece</p>	<p>#8</p>  <p>5/16" Nut 12 Piece</p>	<p>#9</p>  <p>Pool Ball 1 Set</p>	<p>#10</p>  <p>Rail Brush 1 Piece</p>	<p>#11</p>  <p>Triangle 1 Piece</p>	<p>#12</p>  <p>Chalk 2 Piece</p>
<p>#13</p>  <p>48" Cue 2 Piece</p>	<p>#14</p>  <p>Wrench 1 Piece</p>				

